



## PVC-U pressure fittings

# 45° PVC ELBOW FEMALE- MALE THREAD ITEM 199



REFERENCE	DESCRIPTION	Net weight	Volumen (m <sup>3</sup> )	Gross weight	Unidades lote
1002292	ELBOW 45° PLAIN/MALE T. 32-1"	0,042333	0,01553	4,56	100
1002293	ELBOW 45° PLAIN/MALE T. 40-1 1/4"	0,074788	0,02244	4,975	60
1002294	ELBOW 45° PLAIN/MALE T.50-1 1/2"	0,12291	0,02244	4,175	30
1002295	ELBOW 45° PLAIN/MALE T. 63-2"	0,188077	0,02244	6,13	30
1002296	ELBOW 45° PLAIN/MALE T. 75-2 1/2"	0,327773	0,00000	10,475	30

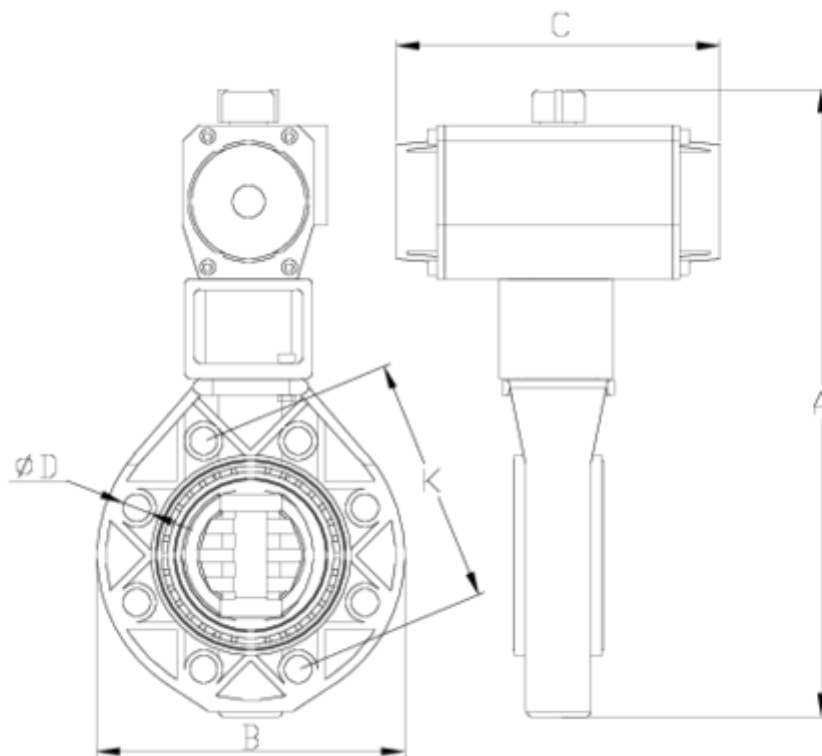

## ITEM 199 | 45° PVC ELBOW FEMALE-MALE THREAD

CÓDIGO	A x a	PESO (g)	C	D	E	F	PN	MEDIDA
02292	32x1"	50	54	19	19	57	PN10	BSP
02293	40x1 1/4"	78	62	22	21	85	PN10	BSP
02294	50x1 1/2"	119	85	26	22	94	PN10	BSP
02295	63x2"	220	102	31	26	109	PN10	BSP
02296	75x2 1/2"	320	131	45	29	115	PN10	BSP



## Product Documents



## Product Certificates



## Company Certificates

