



Vannes à boisseau 3 voies 'Security'

SORTIE TARAUDÉE - FPM

ITEM 854

RÉFÉRENCE	DESCRIPTION	Poids net	Volume (m ³)	Poids brut	Unités par lot
111V113	VÁLVULA BOLA 3 VÍAS MODELO "L" S/R/H 1" VITON	0,681	0,03129	3,8579	4
111V115	VÁLVULA BOLA 3 VÍAS MODELO "L" S/R/H 1 1/2" VITON	1,6964	0,04460	4,8669	2
111V116	VÁLVULA BOLA 3 VÍAS MODELO "L" S/R/H 2" VITON	2,539	0,04460	6,5479	2
111V117	VÁLVULA BOLA 3 VÍAS MODELO "L" S/R/H 2 1/2" VITON	4,9559	0,04836	6,746	1
111V153	VÁLVULA BOLA 3 VÍAS MODELO "T" S/R/H 1" VITON	0,678	0,03129	3,8459	4
111V155	VÁLVULA BOLA 3 VÍAS MODELO "T" S/R/H 1 1/2" VITON	1,6964	0,04460	4,8669	2
111V156	VÁLVULA BOLA 3 VÍAS MODELO "T" S/R/H 2" VITON	2,539	0,04460	6,5479	2
111V157	VÁLVULA BOLA 3 VÍAS MODELO "T" S/R/H 2 1/2" VITON	4,9559	0,04836	6,746	1



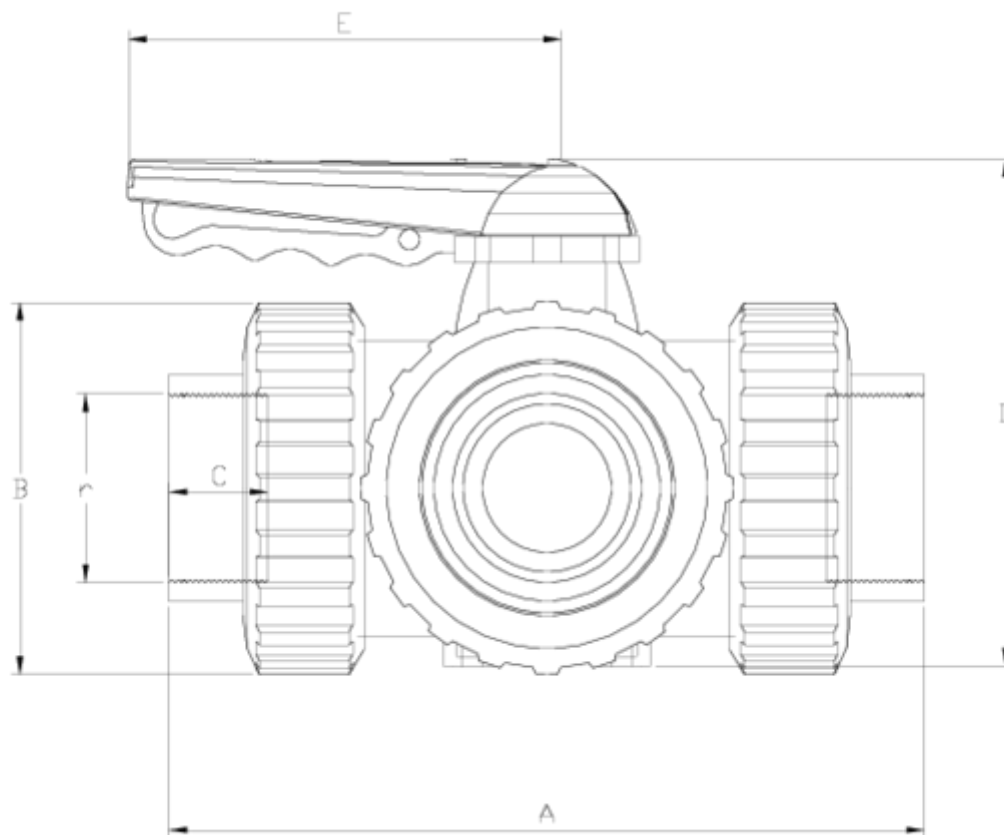

ITEM 854 | SORTIE TARAUDÉE - FPM

VITÓN	r	PESO (g)	DN	Modelo	A	B	C	D	E	PN	TIPO ROSCA
11V113	1"	736	25	L	162	72	23	121	114	PN16	BSP
11V115	1 1/2"	1731	40	L	210	103	33	155	140	PN16	BSP
11V116	2"	2618	50	L	261	120	29	172	140	PN16	BSP
11V117	2 1/2"	5113	65	L	322	150	33	218	160	PN10	BSP
11V153	1"	732	25	T	162	72	23	121	114	PN16	BSP
11V155	1 1/2"	1721	40	T	210	103	33	155	140	PN16	BSP
11V156	2"	2600	50	T	261	120	29	172	140	PN16	BSP
11V157	2 1/2"	5073	65	T	322	150	33	218	160	PN10	BSP





Documentation Produit



Certifications de produits

Certificats d'entreprise

